



BERTI[®]
MACCHINE AGRICOLE

**EKR
EKR/M
EKR/S
TBM
TBM/S
BIMAX
DUAL
XPRO
XPRO/F**



Trinciatrici per aree verdi e terreni incolti per trattori da 30 a 250 HP



Mulchers for green areas and uncultivated fields for tractors from 30 to 250 HP



Mulchgeräte für Brachlandpflege für Traktoren von 30 bis 250 PS



Broyeurs pour espaces verts et terrains incultes pour tracteurs de 30 a 250 CV



Trituradoras para áreas verdes y terrenos no cultivados para tractores de 30 a 250 CV

EKR



Trinciatrice compatta reversibile applicabile in posizione frontale o posteriore al trattore oppure su trattori con guida retroversa. Per trattori con potenze comprese tra 30 e 70 HP. Consigliata per la trinciatura di erba cespugli rovi e ramaglia fino a Ø 2-3 cm. È ideale in generale per la pulizia di campi aperti, set-aside, e su vigneti.



Front and rear compact mulcher to fit tractors from 30 to 70 HP. Suited to mulch grass, bushes, scrub and pruning up to Ø 2-3 cm, it is ideal for general clearing of open field, set aside purposes and on vineyards.











Heck und Frontanbau Gerät für Gras, Stillelegung und Reisig bis Ø 2-3 cm, für Traktoren von 30 bis 70 PS. Es eignet sich für Brachlandpflege, Wiesen, Gründüngung und Obstanlagen.



Broyeur réversible pour tracteurs de 30 à 70 CV. Il est indiqué pour broyer l'herbe, les buissons, et les sarments allants jusqu'à Ø 2-3 cm; il est idéal pour le nettoyage général des champs ouverts ou des vignobles ou pour des applications similaires.

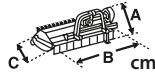

Trituradora compacta reversible aplicable en posición frontal o posterior al tractor o en tractores con conducción invertida. Para tractores con potencias comprendidas entre 30 y 70 HP. Recomendada para el triturado de yerba, arbustos zarzamoras y ramaje hasta Ø 2-3 cm. Es ideal en general para la limpieza de campos abiertos, set-aside, y viñedos.

| Mod. |  |  | |  | |  |  |  |  |  | | |  |  |
|----------------|---|---|-----|---|------|---|---|--|---|---|-----|----|---|---|
| | cm | Min | Max | mm | | n° | n° | n° | PTO | A | B | C | min | max |
| EKR 125 | 125 | 30 | 55 | 615 | 635 | 12 | 36 | 3 | 540 (1000) | 73 | 137 | 78 | 300 | 355 |
| EKR 135 | 135 | 30 | 55 | 615 | 735 | 12 | 36 | 3 | 540 (1000) | 73 | 147 | 78 | 315 | 370 |
| EKR 145 | 145 | 40 | 55 | 615 | 835 | 14 | 42 | 3 | 540 (1000) | 73 | 157 | 78 | 330 | 380 |
| EKR 160 | 160 | 40 | 55 | 715 | 885 | 14 | 42 | 3 | 540 (1000) | 73 | 172 | 78 | 360 | 400 |
| EKR 180 | 180 | 50 | 70 | 780 | 1020 | 16 | 48 | 4 | 540 (1000) | 75 | 195 | 78 | 480 | 520 |
| EKR 200 | 200 | 50 | 70 | 950 | 1050 | 18 | 54 | 4 | 540 (1000) | 75 | 215 | 78 | 520 | 560 |



- Attacco ai tre punti fisso e reversibile, Cat. I-II e tirante fisso al terzo punto.
- Fixed and reversible 3-point linkage, Cat. I-II and top link tie rod
- Fester und umkehrbarer Dreipunktbock, Kat. I-II und oberlenker feste Zugstange.
- Attelage fixe et réversible à 3 points, Cat. I-II et tige de renfort au troisième point.
- Enganche a los tres puntos fijo y reversible, Cat. I-II y tirante fijo en el tercer punto.



- Rullo posteriore autopulente regolabile in altezza
- Self-cleaning and adjustable rear roller
- Einstellbare, selbstreinigende Stützwalze
- Rouleau palpeur autonettoyant réglable en hauteur
- Rodillo posterior autolimpiante regulable en altura



- Scatola ingranaggi con albero passante e ruota libera.
- Through-shaft and free wheel in the gearbox.
- Getriebe mit Durchtrieb und Freilauf.
- Boîtier avec arbre de sortie arrière et roue libre.
- Caja de transmisión con eje cardan passante y rueda libre.



- PTO 540/1000 g/min (invertendo le pulegge).
- PTO 540/1000 rpm (reversing the pulleys).
- Getriebe 540 oder 1000 U/min (Umkehrbare Riemenscheibe).
- PDF 540/1000 t/min (en inversant les poulies).
- PTO 540/1000 g/min (invirtiendo las poleas).



EKR 115→160
Optional



EKR 180→200
Optional

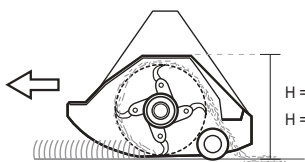

H = 43 cm (115-160)
H = 45 cm (180-200)

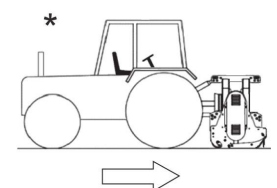
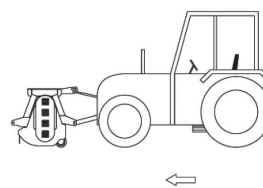
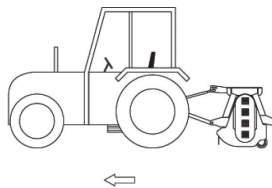

- * Solo con scatola ingranaggi con doppia ruota libera • Gearbox with double free wheel (mandatory)
- Getriebe mit doppeltem Freilauf (bindend) • Double roue libre dans le boîtier (obligatoire)
- Doble rueda libre en la caja de transmisión (obligatorio).

OPTIONALS



- Scatola ingranaggi con doppia ruota libera.
- Gearbox with double free wheel.
- Getriebe mit doppeltem Freilauf.
- Double roue libre dans le boîtier.
- Doble rueda libre en la caja de transmisión.



- Slitte d'appoggio antiusura.
- Skids of anti-wearing steel.
- Satz Kufen mit Anti-Verschleißmaterial.
- Jeu patins anti-usure.
- Patines de acero reforzado anti-desgaste.



- Albero cardanico.
- Pto drive shaft.
- Gelenkwelle.
- Arbre cardan.
- Cardan.

EKR/M



Trinciatrice compatta applicabile in posizione frontale al trattore o posteriore per uso in spinta su trattori a guida retroversa con potenza compresa tra 50 e 90 HP.
Consigliata per la trinciatura di erba, cespugli, rovi e ramaglia fino a Ø 4-5 cm. È ideale in genere per la pulizia di aree verdi, bordi stradali, vigneti e frutteti.



Front-use mulcher to fit tractors from 50 to 90 HP.
Suited to mulch grass, bushes, scrub and pruning (up to Ø 4-5 cm.). It is ideal for general clearing of green areas, road sides, steep slopes, vineyards and orchards.



Frontanbau Gerät für Gras, Stillelegung und Reisig bis 4-5 cm. Ø, für Sonder-Spurtraktoren und Geräteträger von 50 bis 90 PS. Es eignet sich für Wiesen, Gründüngung und Obstanlagen.



Broyeur seulement avant pour tracteurs de 50 à 90 HP.
Il est indiqué pour broyer l'herbe, les buissons, le matériel ligneux et les sarments jusqu'à Ø 4-5 cm. ; il est idéal pour le nettoyage général des espaces verts ou des vignobles et pour des applications similaires.



Trituradora compacta aplicable en posición frontal al tractor o posterior para uso en empuje en tractores de conducción invertida con potencia comprendida entre 50 y 90 HP. Recomendada para el triturado de yerba, arbustos, zarzamoras y ramaje hasta Ø 4-5 cm. Es ideal en general para la limpieza de áreas verdes, bordes de carreteras, viñedos y huertos frutales.

| Mod. | | | | | | | | | | | | | |
|------------------|-----|-----|-----|------------|----|----|----|------------|----|-----|----|-----|-----|
| | cm | Min | Max | mm | n° | n° | n° | PTO | A | B | C | min | max |
| EKR/M 180 | 180 | 50 | 90 | 1020 780 | 16 | 48 | 4 | 540 (1000) | 80 | 200 | 90 | 460 | 525 |
| EKR/M 200 | 200 | 50 | 90 | 1050 950 | 18 | 54 | 4 | 540 (1000) | 80 | 220 | 90 | 510 | 575 |

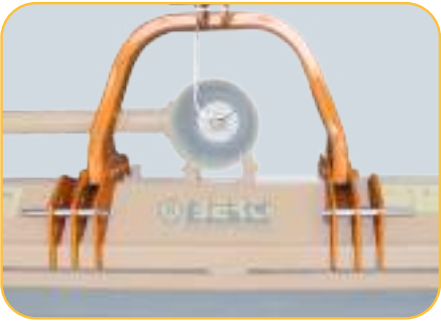

- Attacco ai 3 punti fisso, Cat. I-II.
- Fixed three points linkage, Cat. I-II.
- Fester Dreipunktbock, Kat. I-II.
- Attelage fixe à 3 points, Cat. I-II.
- Enganche fijo a los 3 puntos, Cat. I-II.



- Rullo posteriore autopulente Ø 159 mm., regolabile in altezza.
- Self-cleaning and adjustable Ø 159 rear roller.
- Einstellbare, selbstreinigende Stützwalze Ø 159
- Rouleau palpeur autonettoyant Ø 159, réglable en hauteur.
- Rodillo posterior autolimpiante Ø 159 mm., regulable en altura.



- Scatola ingranaggi con doppia ruota libera.
- Double free wheel in the gearbox.
- Getriebe mit doppeltem Freilauf.
- Boîtier avec double roue libre.
- Caja de transmisión con doble rueda libre.



- PTO 540/1000 g/min (invertendo le pulegge).
- PTO 540/1000 rpm (reversing the pulleys).
- Getriebe 540 oder 1000 U/min (Umkehrbare Riemenscheibe).
- PDF 540/1000 t/min (en inversant les poulies).
- PTO 540/1000 g/min (invirtiendo las poleas).



Optional

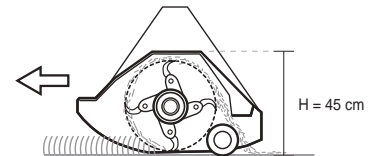

OPTIONALS



- Slitte d'appoggio antiusura.
- Skids of anti-wearing steel.
- Satz Kufen mit Anti-Verschleißmaterial.
- Jeu patins anti-usure.
- Patines de acero reforzado anti-desgaste.



- Albero cardanico.
- Pto drive shaft.
- Gelenkwelle.
- Arbre cardan.
- Cardan.

EKR/S



Trinciatrice reversibile applicabile in posizione frontale o posteriore al trattore oppure su trattori con guida retroversa. Da applicare a trattori con potenze comprese tra 50 e 130 HP. Consigliata per la trinciatura di erba cespugli rovi e ramaglia fino a Ø 4-5 cm. E' ideale in generale per la pulizia di campi aperti, set-aside e su vigneti.



Front and rear mulcher to fit tractors from 50 to 130 HP. Suited to mulch grass, bushes, scrub and pruning up to Ø 4-5 cm., it is ideal for general clearing of open field, set aside purposes and on vineyards.











Heck und Frontanbau Gerät mit Seitenverschiebung für Gras, Stillelegung und Reisig bis Ø 4-5 cm, für Traktoren von 50 bis 130 PS. Es eignet sich für Brachlandpflege, Wiesen, Gründüngung und Obstanlagen.



Broyeur réversible pour tracteurs de 50 à 130 HP. Il est indiqué pour broyer l'herbe, les buissons, le matériel ligneux et les sarments jusqu'à Ø 4-5 cm; il est idéal pour le nettoyage général des champs ouverts ou des vignobles et pour des applications similaires.

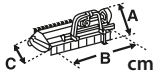

Trituradora reversible aplicable en posición frontal o posterior al tractor o en tractores con conducción invertida. De aplicar a tractores con potencias comprendidas entre 50 y 130 HP. Recomendada para el triturado de yerba, arbustos zarzamoras y ramaje hasta Ø 4-5 cm. Es ideal en general para la limpieza de campos abiertos, set-aside, y viñedos.

| Mod. |  |  | |  |  |  |  |  |  |  |  | | |
|------------------|---|---|-----|---|---|---|--|---|---|---|---|-----|------|
| | cm | Min | Max | mm | n° | n° | n° | PTO | A | B | C | min | max |
| EKR/S 180 | 180 | 50 | 100 | 1040 760 520 1280 1210 790 | 16 | 48 | 4 | 540 (1000) | 96 | 198 | 100 | 560 | 710 |
| EKR/S 200 | 200 | 50 | 100 | 690 1310 1320 880 | 18 | 54 | 4 | 540 (1000) | 96 | 218 | 100 | 600 | 740 |
| EKR/S 220 | 220 | 60 | 100 | 800 1400 1320 1180 | 20 | 60 | 4 | 540 (1000) | 96 | 238 | 100 | 630 | 770 |
| EKR/S 250 | 250 | 60 | 130 | 800 1700 | 22 | 66 | 4 | 540 (1000) | 98 | 268 | 100 | 690 | 830 |
| EKR/S 280 | 280 | 70 | 130 | 1610 1190 1040 1760 | 26 | 78 | 4 | 540 (1000) | 95 | 300 | 101 | 890 | 1030 |
| EKR/S 300 | 300 | 70 | 130 | 1610 1390 1040 1960 | 28 | 84 | 4 | 540 (1000) | 101 | 318 | 105 | 920 | 1060 |



- Attacco a tre punti reversibile e spostabile meccanicamente, Cat. II.
- Displaceable and reversible 3-point linkage, Cat. II. (mechanical).
- Umkehrbarer und versetzbarer Dreipunktbock, Kat. II (mechanischer).
- Attelage déportable et réversible à 3 points, Cat. II (mécanique).
- Eganche a los 3 puntos desplazable y reversible, Cat. II (mecánico).



- Rullo posteriore autopulente Ø 159 mm., regolabile in altezza (Ø194 EKR/S 270-300).
- Self-cleaning and adjustable Ø 159 rear roller (Ø194 EKR/S 270-300).
- Einstellbare, selbstreinigende Stützwalze Ø 159 (Ø194 EKR/S 270-300).
- Rouleau palpeur autonettoyant Ø 159, réglable en hauteur (Ø194 EKR/S 270-300).
- Rodillo posterior autolimpiante Ø 159 mm., regulable en altura (Ø194 EKR/S 270-300).



- Scatola ingranaggi con albero passante e ruota libera.
- Through-shaft and free wheel in the gearbox.
- Getriebe mit Durchtrieb und Freilauf.
- Boîtier avec arbre de sortie arrière et roue libre.
- Caja de transmisión con eje cardan passante y rueda libre.



Optional

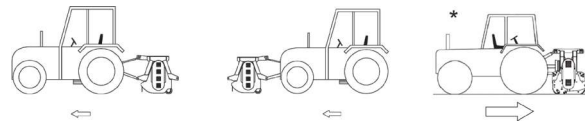

- * Solo con scatola ingranaggi con doppia ruota libera.
- Gearbox with double free wheel (mandatory).
- Getriebe mit doppeltem Freilauf (bindend).
- Double roue libre dans le boîtier (obligatoire).
- Doble rueda libre en la caja de transmisión (obligatorio).



- PTO 540/1000 g/min (invertendo le pulegge).
- PTO 540/1000 rpm (reversing the pulleys).
- Getriebe 540 oder 1000 U/min (Umkehrbare Riemenscheibe).
- PDF 540/1000 t/min (en inversant les poulies).
- PTO 540/1000 g/min (invirtiendo las poleas).

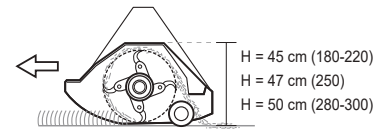

- H = 45 cm (180-220)
- H = 47 cm (250)
- H = 50 cm (280-300)

OPTIONALS



- Spostamento idraulico con tubi e innesti rapidi.
- Hydraulic side shift with hoses and quick couplings.
- Hydraulische Seitenverschiebung mit Schnellkupplungen.
- Déport hydraulique avec tuyaux et prises rapides.
- Desplazamiento lateral de accionamiento hidráulico.



- Kit segnaletica stradale con luci.
- Set road-warning panels with lights.
- Satz Warntafel mit Beleuchtung.
- Kit de signalisation avec système d'éclairage.
- Kit de señalización de carretera con luces.



- Doppio attacco ai tre punti.
- Double 3-points linkage.
- Doppelter Dreipunktbock.
- Double attelage à 3 points.
- Doble eganche a los 3 puntos.



- Scatola ingranaggi con doppia ruota libera.
- Gearbox with double free wheel.
- Getriebe mit doppeltem Freilauf.
- Double roue libre dans le boîtier.
- Doble rueda libre en la caja de transmisión.



- Slitte d'appoggio antiusura.
- Skids of anti-wearing steel.
- Satz Kufen mit Anti-Verschleißmaterial.
- Jeu patins anti-usure.
- Patines de acero reforzado anti-desgaste.



- Albero cardanico.
- Pto drive shaft.
- Gelenkwelle.
- Arbre cardan.
- Cardan.

TBM



STRENX®
PERFORMANCE STEEL



Trinciatrice da applicare a trattori con potenza compresa tra 50 a 110 HP. È consigliata per trinciare erba, cespugli, rovi stocchi di mais e ramaglia in generale fino a Ø 5-7 cm. Ideale in generale per applicazioni su manutenzione del verde, set-aside, parchi, aree verdi e vigneti.



Mulcher, rear mounted, to fit tractors from 50 to 110 HP. It is suited to mulch grass, bushes, maize stalks, corn stalks, scrub and pruning up to Ø 5-7 cm., ideal for general clearing of open-field crops, green areas, parks, gardens, vineyards and for set aside applications.











Gerät für Gras, Stilllegung, Stroh und Reisig bis Ø 5-7 cm., für Traktoren von 50 bis 110 PS. Es eignet sich für Brachlandpflege, Wiesen, Gründüngung und Obstanlagen.



Broyeur postérieur pour tracteurs de 50 à 110 CV. Il est indiqué pour broyer l'herbe, les buissons, les tiges de maïs et de céréales, et les sarments allant jusqu'à Ø 5-7 cm. Il est idéal pour les nettoyages généraux des cultures en champs ouverts, des espaces verts, des parcs, des jardins, des vignobles ou pour des applications similaires.

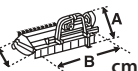

Trituradora de aplicar a tractores con potencias comprendidas entre 50 y 110 HP. Está recomendada para triturar yerba, arbustos, zarzamoras, tallos de maíz y ramaje en general hasta Ø 5-7 cm. Ideal en general para aplicaciones en mantenimiento del verde, set-aside, parques, áreas verdes y viñedos.

| Mod. |  cm |  HP | |  mm |  n° |  n° |  n° |  PTO |  cm | | |  KG | |
|----------------|---|---|-----|---|---|---|--|--|---|-----|-----|---|------|
| | | Min | Max | | | | | | A | B | C | min | max |
| TBM 180 | 180 | 50 | 110 | 875 925 355 1445 | 16 | 48 | 4 | 540 (1000) | 100 | 198 | 100 | 735 | 815 |
| TBM 200 | 200 | 50 | 110 | 1040 960 520 1480 | 18 | 54 | 4 | 540 (1000) | 100 | 218 | 100 | 780 | 870 |
| TBM 220 | 220 | 60 | 110 | 1040 1160 520 1680 | 20 | 60 | 4 | 540 (1000) | 100 | 238 | 100 | 820 | 920 |
| TBM 250 | 250 | 60 | 110 | 1040 1460 520 1980 | 22 | 66 | 4 | 540 (1000) | 115 | 268 | 100 | 905 | 1025 |
| TBM 270 | 270 | 60 | 110 | 1040 1660 520 2180 | 24 | 72 | 4 | 540 (1000) | 115 | 288 | 100 | 935 | 1070 |



- Attacco ai 3 punti spostabile meccanicamente, Cat. II.
- Displaceable three points linkage, Cat. II (mechanical).
- Versetzbarer Dreipunktbock, Kat. II (mechanischer).
- Attelage déportable à 3 points, Cat. II (mécanique).
- Enganche desplazable a los 3 puntos Cat. II (mecánico).



- Rullo posteriore autopulente Ø 194 mm., regolabile in altezza.
- Self-cleaning and adjustable Ø 194 rear roller.
- Einstellbare, selbstreinigende Stützwalze Ø 194.
- Rouleau palpeur autonettoyant Ø 194, réglable en hauteur.
- Rodillo posterior autolimpiante Ø 194 mm., regulable en altura.



- Tenditore automatico delle cinghie.
- Full automatic belts adjuster.
- Automatische Riemenspannung.
- Tendeur automatique des courroies.
- Tensor automático de las correas.



- Slitte d'appoggio antiusura.
- Skids of anti-wearing steel.
- Satz Kufen mit Anti-Verschleißmaterial.
- Jeu patins anti-usure.
- Patines de acero reforzado anti-desgaste.



- PTO 540/1000 g/min (invertendo le pulegge).
- PTO 540/1000 rpm (reversing the pulleys).
- Getriebe 540 oder 1000 U/min (Umkehrbare Riemenscheibe).
- PDF 540/1000 t/min (en inversant les poulies).
- PTO 540/1000 g/min (invirtiendo las poleas).



Optional

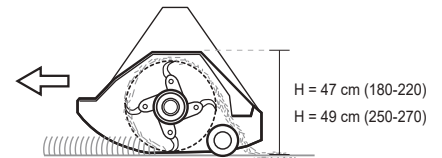

OPTIONALS



- Spostamento idraulico con tubi e innesti rapidi.
- Hydraulic side shift with hoses and quick couplings.
- Hydraulische Seitenverschiebung mit Schnellkupplungen.
- Déport hydalrique avec tuyaux et prises rapides.
- Desplazamiento lateral de accionamiento hidráulico.



- Kit segnaletica stradale con luci.
- Set road-warning panels with lights.
- Satz Warntafel mit Beleuchtung.
- Kit de signalisation avec système d'éclairage.
- Kit de señalización de carretera con luces.



- Attacco centrale.
- Centre mounted linkage.
- Mittiger Anbau.
- Attelage axial.
- Enganche central.

| Mod. | mm | |
|------|----------------|-------------|
| | TBM 270 | 1587 1113 |



- Ruote sterzanti.
- Steering wheels.
- Hinterlenkräder.
- Roues directrices.
- Ruedas directrices.



- Pulirullo.
- Roller scraper.
- Satz Walzenabstreifer.
- Décrottoir à rouleau.
- Polirodillo.



- Albero cardanico.
- Pto drive shaft.
- Gelenkwelle.
- Arbre cardan.
- Cardan.

TBM/S



STRENX®
PERFORMANCE STEEL



Trinciatrice da applicare a trattori con potenza compresa tra 75 a 150 HP. E' consigliata per trinciare erba, cespugli, rovi stocchi di mais e ramaglia in generale fino a Ø 6-8 cm. Ideale in generale per applicazioni su manutenzione del verde, set-aside, parchi, aree verdi e vigneti.



Heavy duty mulcher, rear mounted, to fit tractors from 75 to 150 HP. It is suited to mulch grass, bushes, maize stalks, corn stalks, sunflowers, gorse, scrub and pruning up to Ø 6-8 cm., ideal for general clearing of uncultivated fields, open-field crops, green areas, under wood, parks, gardens, and for set aside applications.











Gerät für Gras, Stillelegung, Stroh, Reisig und Äste bis Ø 6-8 cm. für Traktoren von 75 bis 150 PS. Es eignet sich für Brachlandpflege, Wiesen, Gründüngung und Obstanlagen.



Broyeur postérieur renforcé pour tracteurs de 75 à 150 CV. Il est indiqué pour broyer l'herbe, les buissons, les tiges de maïs et de céréales, les tournesols, les ronces, et les sarments allant jusqu'à Ø 6-8 cm; idéal pour les nettoyages généraux sur des terrains incultes, des cultures en champs ouverts, des espaces verts, du sous-bois, des parcs et des jardins ou pour des applications similaires.



Trituradora de aplicar a tractores con potencia comprendida entre 75 y 150 HP. Está recomendada para triturar yerba, arbustos, zarcamoras, tallos de maíz y ramaje en general hasta a Ø 6-8 cm. Ideal en general para aplicaciones en mantenimiento del verde, set-aside, parques, áreas verdes y viñedos.

| Mod. |  cm |  HP | |  mm |  n° |  n° |  n° |  PTO |  cm | | |  KG | |
|------------------|---|---|-----|---|---|---|--|--|---|-----|-----|---|------|
| | | Min | Max | | | | | | A | B | C | min | max |
| TBM/S 180 | 180 | 75 | 150 | 875 925 355 1445 | 16 | 48 | 5 | 1000 (540) | 100 | 198 | 105 | 845 | 955 |
| TBM/S 200 | 200 | 75 | 150 | 1040 960 520 1480 | 18 | 54 | 5 | 1000 (540) | 100 | 218 | 105 | 890 | 1020 |
| TBM/S 220 | 220 | 75 | 150 | 1040 1160 520 1680 | 20 | 60 | 5 | 1000 (540) | 100 | 238 | 105 | 935 | 1080 |
| TBM/S 250 | 250 | 75 | 150 | 1040 1460 520 1980 | 22 | 66 | 5 | 1000 (540) | 100 | 268 | 105 | 1000 | 1160 |
| TBM/S 280 | 280 | 85 | 150 | 1050 1750 530 2270 | 26 | 78 | 5 | 1000 (540) | 125 | 300 | 116 | 1090 | 1260 |
| TBM/S 300 | 300 | 85 | 150 | 1040 1960 520 2480 | 28 | 84 | 5 | 1000 (540) | 100 | 318 | 105 | 1135 | 1270 |



- Attacco ai 3 punti spostabile meccanicamente, Cat. II.
- Displaceable three points linkage, Cat. II (mechanical).
- Versetzbarer Dreipunktbock, Kat. II (mechanischer).
- Attelage deportable à 3 points, Cat. II (mécanique).
- Enganche desplazable a los 3 puntos Cat. II (mecánico).



- Rullo posteriore autopulente Ø 194 mm., regolabile in altezza.
- Self-cleaning and adjustable Ø 194 rear roller.
- Einstellbare, selbstreinigende Stützwalze Ø 194.
- Rouleau palpeur autonettoyant Ø 194, réglable en hauteur.
- Rodillo posterior autolimpiante Ø 194 mm., regulable en altura.



- Tenditore automatico delle cinghie.
- Full automatic belts adjuster.
- Automatische Riemenspannung.
- Tendeur automatique des courroies.
- Tensor automático de las correas.



- Slitte d'appoggio antiusura.
- Skids of anti-wearing steel.
- Satz Kufen mit Anti-Verschleißmaterial.
- Jeu patins anti-usure.
- Patines de acero reforzado anti-desgaste.



Optional

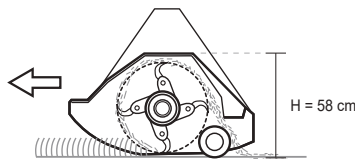

- Attacco centrale.
- Centre mounted linkage.
- Mittiger Anbau.
- Attelage axial.
- Enganche central.

OPTIONALS



- Spostamento idraulico con tubi e innesti rapidi.
- Hydraulic side shift with hoses and quick couplings.
- Hydraulische Seitenverschiebung mit Schnellkupplungen.
- Déport hydraulique avec tuyaux et prises rapides.
- Desplazamiento lateral de accionamiento hidráulico.



- Kit segnaletica stradale con luci.
- Set road-warning panels with lights.
- Satz Warntafel mit Beleuchtung.
- Kit de signalisation avec système d'éclairage.
- Kit de señalización de carretera con luces.



- Ruote sterzanti.
- Steering wheels.
- Hinterlenkräder.
- Roues directrices.
- Ruedas directrices.



- Pulirullo.
- Roller scraper.
- Satz Walzenabstreifer.
- Décrottoir à rouleau.
- Polirodillo.



- Rotore Mega.
- Rotor type Mega.
- Rotor Typ Mega.
- Rotor type Mega.
- Rotor tipo Mega.



- Albero cardanico.
- Pto drive shaft.
- Gelenkwelle.
- Arbre cardan.
- Cardan.

| Mod. | mm | |
|------------------|------|------|
| | 1616 | 1084 |
| TBM/S 280 | 1094 | 1606 |
| TBM/S 300 | 1616 | 1384 |
| | 1094 | 1906 |

BIMAX





- Tenditore automatico delle cinghie.
- Full automatic belts adjuster.
- Automatische Riemenspannung.
- Tendeur automatique des courroies.
- Tensor automático de las correas.

STRENX®
PERFORMANCE STEEL









 Trinciatrice reversibile applicabile in posizione frontale o posteriore al trattore oppure su trattori con guida retroversa. Da applicare a trattori con potenze comprese tra 50 e 130 HP. Consigliata per la trinciatura di erba cespugli rovi e ramaglia fino a Ø 5-6 cm. E' ideale in generale per la pulizia di campi aperti, set-aside e su vigneti.

 Broyeur réversible pour tracteurs de 50 à 130 HP. Il est indiqué pour broyer l'herbe, les buissons, le matériel ligneux et les sarments jusqu'à Ø 5-6 cm; il est idéal pour le nettoyage général des champs ouverts ou des vignobles et pour des applications similaires.

 Front and rear mulcher to fit tractors from 50 to 130 HP. Suited to mulch grass, bushes, scrub and pruning up to Ø 5-6 cm., it is ideal for general clearing of open field, set aside purposes and on vineyards.

 Trituradora reversible aplicable en posición frontal o posterior al tractor o en tractores con conducción invertida. De aplicar a tractores con potencias comprendidas entre 50 y 130 HP. Recomendada para el triturado de yerba, arbustos zarzamoras y ramaje hasta Ø 5-6 cm. Es ideal en general para la limpieza de campos abiertos, set-aside, y viñedos.

 Heck und Frontanbau Gerät mit Seitenverschiebung für Gras, Stillelegung und Reisig bis Ø 5-6 cm, für Traktoren von 50 bis 130 PS. Es eignet sich für Brachlandpflege, Wiesen, Gründüngung und Obstanlagen.

| Mod. |  |  | |  |  |  |  |  |  | |  | | |
|------------------|---|---|-----|---|---|---|---|---|---|-----|---|-----|------|
| | cm | Min | Max | mm | n° | n° | n° | | PTO | A | B | C | min |
| BIMAX 180 | 180 | 50 | 100 | 1040 760 520 1280 | 16 | 48 | 4 | 1000 (540) | 100 | 200 | 125 | 730 | 870 |
| BIMAX 200 | 200 | 50 | 100 | 1210 790 690 1310 | 18 | 54 | 4 | 1000 (540) | 100 | 220 | 125 | 765 | 905 |
| BIMAX 220 | 220 | 60 | 100 | 1320 880 800 1400 | 20 | 60 | 4 | 1000 (540) | 100 | 240 | 125 | 800 | 940 |
| BIMAX 250 | 250 | 60 | 130 | 1320 1180 800 1700 | 22 | 66 | 4 | 1000 (540) | 103 | 270 | 125 | 850 | 990 |
| BIMAX 280 | 280 | 70 | 130 | 1610 1190 1040 1760 | 26 | 78 | 4 | 1000 (540) | 106 | 300 | 125 | 905 | 1045 |
| BIMAX 300 | 300 | 70 | 130 | 1610 1390 1040 1960 | 28 | 84 | 4 | 1000 (540) | 106 | 320 | 125 | 940 | 1080 |



- Doppio attacco a tre punti reversibile e spostabile meccanicamente, Cat. II.
- Double displaceable and reversible 3-point linkage, Cat. II. (mechanical).
- Doppelter und versetzbarer Dreipunktbock, Kat. II (mechanischer).
- Double attelage déportable et réversible à 3 points, Cat. II (mécanique).
- Doble engancho a los 3 puntos desplazable y reversible, Cat. II (mecánico).



- PTO 540/1000 g/min (invertendo le pulegge).
- PTO 540/1000 rpm (reversing the pulleys).
- Getriebe 540 oder 1000 U/min (Umkehrbare Riemenscheibe).
- PDF 540/1000 t/min (en inversant les poulies).
- PTO 540/1000 g/min (invirtiendo las poleas).



- Rullo posteriore autopulente regolabile in altezza.
- Self-cleaning and adjustable rear roller.
- Einstellbare, selbstreinigende Stützwalze.
- Rouleau palpeur autonettoyant réglable en hauteur.
- Rodillo posterior autolimpiante regulable en altura.



- Scatola ingranaggi con albero passante e doppia ruota libera.
- Through-shaft and double free wheel in the gearbox.
- Getriebe mit Durchtrieb und doppelter Freilauf.
- Boîtier avec arbre de sortie arrière et double roue libre.
- Caja de transmisión con eje cardan passante y doble rueda libre.



Optional

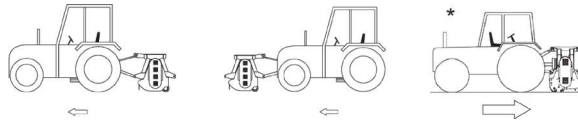

- * Solo con scatola ingranaggi con doppia ruota libera.
- * Gearbox with double free wheel (mandatory).
- * Getriebe mit doppeltem Freilauf (bindend).
- * Double roue libre dans le boîtier (obligatoire).
- * Doble rueda libre en la caja de transmisión (obligatorio).

OPTIONALS



- Spostamento idraulico con tubi e innesti rapidi.
- Hydraulic side shift with hoses and quick couplings.
- Hydraulische Seitenverschiebung mit Schnellkupplungen.
- Déport hydraulique avec tuyaux et prises rapides.
- Desplazamiento lateral de accionamiento hidráulico.



- Protezioni frontali in catena.
- Front chains protectors.
- Frontschutz mit Ketten.
- Protections frontales par chaînes.
- Protecciones frontales en cadena.

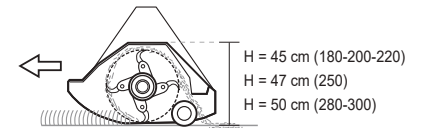

- Kit segnaletica stradale con luci.
- Set road-warning panels with lights.
- Satz Warntafel mit Beleuchtung.
- Kit de signalisation avec système d'éclairage.
- Kit de señalización de carretera con luces.



- Slitte d'appoggio antiusura.
- Skids of anti-wearing steel.
- Satz Kufen mit Anti-Verschleißmaterial.
- Jeu patins anti-usure.
- Patines de acero reforzado anti-desgaste.



- Albero cardanico.
- Pto drive shaft.
- Gelenkwelle.
- Arbre cardan.
- Cardan.

DUAL



STRENX®
PERFORMANCE STEEL



Trinciatrice reversibile applicabile in posizione frontale o posteriore al trattore oppure su trattori con guida retroversa. Da applicare a trattori con potenze comprese tra 70 e 160 HP. Consigliata per la trinciatura di erba cespugli rovi stocchi di mais e ramaglia fino a Ø 6-8 cm è ideale in generale per la pulizia di parchi, aree verdi, set-aside.



Front and rear mulcher to fit tractors from 70 to 160 HP. It is suited to mulch grass, bushes, maize stalks, corn stalks, sunflowers, scrub and pruning up to Ø 6-8 cm., ideal for general clearing of open-field crops, green areas, parks, gardens, and for set aside applications.



Front- und Heckanbau Gerät mit Seitenverschiebung, für Gras, Stilllegung, Stroh und Reisig bis Ø 6-8 cm. Es eignet sich für Brachlandpflege, Wiesen, Gründüngung und Obstanlagen, für Traktoren von 70 bis 160 PS.



Broyeur réversible pour tracteurs de 70 à 160 CV. Il est indiqué pour broyer l'herbe, les buissons, les tiges de maïs et de céréales, les tournesols, et les sarments allant jusqu'à Ø 6-8 cm; idéal pour les nettoyages généraux des cultures en champs ouverts, des espaces verts, du sous-bois, des parcs et des jardins ou pour des applications similaires.



Trituradora reversible aplicable en posición frontal o posterior al tractor o en tractores con conducción invertida. De aplicar a tractores con potencias comprendidas entre 70 y 160 HP. Recomendada para el triturado de yerba, arbustos, zarzamoras, tallos de maíz y ramaje hasta Ø 6-8 cm es ideal en general para la limpieza de parques, áreas verdes, set-aside.

| Mod. | | | | | | | | | | | | | |
|-----------------|-----|-----|-----|------------------------|----|----|----|------------|-----|-----|-----|------|------|
| | cm | Min | Max | mm | n° | n° | n° | PTO | A | B | C | min | max |
| DUAL 200 | 200 | 70 | 160 | 1040 960 520 1480 | 18 | 54 | 4 | 1000 (540) | 105 | 220 | 120 | 875 | 975 |
| DUAL 230 | 230 | 70 | 160 | 1320 980 800 1500 | 20 | 60 | 4 | 1000 (540) | 105 | 250 | 120 | 940 | 1040 |
| DUAL 250 | 250 | 70 | 160 | 1320 1180 800 1700 | 22 | 66 | 4 | 1000 (540) | 105 | 270 | 120 | 990 | 1090 |
| DUAL 280 | 280 | 90 | 160 | 1610 1190 1090 1710 | 26 | 78 | 4 | 1000 (540) | 105 | 300 | 120 | 1070 | 1170 |
| DUAL 300 | 300 | 70 | 160 | 1610 1390 1090 1910 | 28 | 84 | 4 | 1000 (540) | 105 | 320 | 120 | 1110 | 1210 |



- Doppio attacco ai tre punti centrale e spostabile meccanicamente, Cat. II.
- Double and displaceable 3-point linkage, centre mounted, Cat. II (mechanical).
- Versetzbarer, doppelter und mittiger Dreipunktbock, Kat. II (mechanischer).
- Double attelage axial et deportable à 3 points, Cat. II (mecanique).
- Doble engancho central y desplazable a los 3 puntos, Cat. II (mecánico).



- Rullo posteriore autopulente Ø 194 mm., regolabile in altezza.
- Self-cleaning and adjustable Ø 194 rear roller.
- Einstellbare, selbstreinigende Stützwalze Ø 194.
- Rouleau palpeur autonettoyant Ø 194, réglable en hauteur.
- Rodillo posterior autolimpiante Ø 194 mm., regulable en altura.



- Slitte d'appoggio antiusura.
- Skids of anti-wearing steel.
- Satz Kufen mit Anti-Verschleißmaterial.
- Jeu patins anti-usure.
- Patines de acero reforzado anti-desgaste.



- Tenditore automatico delle cinghie.
- Full automatic belts adjuster.
- Automatische Riemenspannung.
- Tendeur automatique des courroies.
- Tensor automático de las correas.



- Scatola ingranaggi con albero passante e doppia ruota libera.
- Through-shaft and double free wheel in the gearbox.
- Getriebe mit Durchtrieb und doppeltem Freilauf.
- Boîtier avec arbre de sortie arrière et double roue libre.
- Caja de transmisión con eje cardan passante y doble rueda libre.

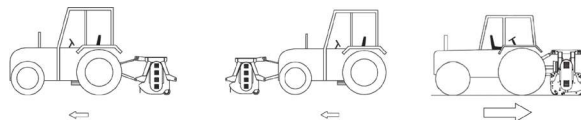

OPTIONALS



- Spostamento idraulico con tubi e innesti rapidi.
- Hydraulic side shift with hoses and quick couplings.
- Hydraulische Seitenverschiebung mit Schnellkupplungen.
- Déport hydraulique avec tuyaux et prises rapides.
- Desplazamiento lateral de accionamiento hidráulico.



- Kit molle anteriori per scarico peso.
- Weight relief springs-kit.
- Entlastungsfeder-Satz.
- Kit de ressorts frontales pour du poids.
- Kit de muelles frontales para el descargue del peso.



Optional

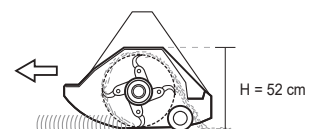

- Kit segnaletica stradale con luci.
- Set road-warning panels with lights.
- Satz Warntafel mit Beleuchtung.
- Kit de signalisation avec système d'éclairage.
- Kit de señalización de carretera con luces.



- Ruote frontali stabilizzatrici.
- Height adjustable front wheels.
- Front-Stützräder, höhenverstellbare.
- Roues frontales réglables en hauteur.
- Ruedas frontales estabilizadoras.



- Albero cardanico.
- Pto drive shaft.
- Gelenkwelle.
- Arbre cardan.
- Cardan.

XPRO



STRENX®
PERFORMANCE STEEL



Trinciatrice professionale, rinforzata reversibile applicabile frontalmente o posteriormente o su trattori con guida retroversa con potenza compresa tra 100 e 250 HP. E' consigliata per la trinciatura di erba, paglia, residui vegetali, cespugli, stocchi di mais, sarmenti e residui legnosi fino a Ø 8-10 cm., per la manutenzione di terreni incolti, aree verdi, set-aside.



Front and rear heavy-duty professional mulcher to fit tractors from 100 to 250 HP. It is suited to mulch grass, bushes, maize stalks, corn stalks, sunflowers, scrub and pruning up to Ø 8-10 cm., ideal for general clearing of uncultivated fields, open-field crops, green areas, parks, gardens, under-wood and for set aside applications.



Verstärktes- und Vielseitig-, Front/Heck- Mulchgerät, für Traktoren von 100 bis 250 PS. Mulcht Gras, Stilllegung, Sonnenblumen, Maisstroh, Gestrüpp und Reisig bis Ø 8-10 cm. Es eignet sich für Brachlandpflege, Wiesen, Gründüngung, Obstanlagen, Mais, Zuckerrohr, Rüben usw.



Broyeur professionnel réversible pour tracteurs de 100 à 250 CV. Il est indiqués pour broyer l'herbe, les buissons, les tiges de maïs et de céréales, les tournesols, et les sarments allant jusqu'à Ø 8-10 cm; il est idéal pour le nettoyage général des terrains incultes, des cultures en champs ouverts, des espaces verts, des parcs, des jardins et du sous-bois ou pour des applications similaires.



Trituradora profesional, reforzada reversible aplicable frontalmente o posteriormente o en tractores con conducción inversa con potencia comprendida entre 100 y 250 HP. Está recomendada para el triturado de yerba, paja, residuos vegetales, arbustos, tallos de maíz, sarmientos y residuos leñosos hasta Ø 8-10 cm., para el mantenimiento de terrenos no cultivados, áreas verdes, set-aside.

| Mod. | | | | | | | | | | | | |
|-----------------|-----|------------|----------------------------|----|----|------------|-----|-----|-----|------|------|--|
| | cm | Min Max | mm | n° | n° | PTO | A | B | C | min | max | |
| XPRO 200 | 200 | 100 250 | 1250 750 730 1270 | 18 | 5 | 1000 (540) | 122 | 220 | 137 | 1275 | 1555 | |
| XPRO 230 | 230 | 100 250 | 1320 980 800 1500 | 20 | 5 | 1000 (540) | 122 | 250 | 137 | 1355 | 1645 | |
| XPRO 250 | 250 | 100 250 | 1500 1000 980 1520 | 22 | 5 | 1000 (540) | 122 | 270 | 137 | 1415 | 1705 | |
| XPRO 280 | 280 | 100 250 | 1610 1190 1090 1710 | 26 | 5 | 1000 (540) | 122 | 300 | 137 | 1520 | 1810 | |
| XPRO 300 | 300 | 100 250 | 1610 1390 1090 1910 | 28 | 5 | 1000 (540) | 122 | 320 | 137 | 1560 | 1850 | |



- Doppio attacco ai tre punti centrale, spostabile idraulicamente, Cat. II-III.
- Double and displaceable 3-point linkage, centre mounted, Cat. II-III (hydraulic).
- Versetzbarer, doppelter und mittiger Dreipunktbock, Kat. II-III (Hydraulischer).
- Double attelage axial et deportable à 3 points, Cat. II-III (hydraulique).
- Doble engancho central y desplazable a los 3 puntos, Cat. II-III (hidráulico).



- Tenditore automatico delle cinghie.
- Full automatic belts adjuster.
- Automatische Riemenspannung.
- Tendeur automatique des courroies.
- Tensor automático de las correas.



- Rullo posteriore autopulente Ø 220 mm., regolabile in altezza.
- Self-cleaning and adjustable Ø 220 rear roller.
- Einstellbare, selbstreinigende Stützwalze Ø 220
- Rouleau palpeur autonettoyant Ø 220, réglable en hauteur.
- Rodillo posterior autolimpiante Ø 220 mm., regulable en altura.



- Scatola ingranaggi con albero passante e doppia ruota libera.
- Through-shaft and double free wheel in the gearbox.
- Getriebe mit Durchtrieb und doppeltem Freilauf.
- Boîtier avec arbre de sortie arrière et double roue libre.
- Caja de transmisión con eje cardan passante y doble rueda libre.



- Slitte d'appoggio antiusura.
- Skids of anti-wearing steel.
- Satz Kufen mit Anti-Verschleißmaterial.
- Jeu patins anti-usure.
- Patines de acero reforzado anti-desgaste.

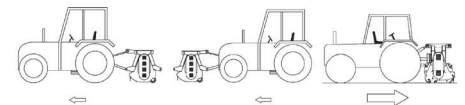

OPTIONALS



- Kit molle anteriori per scarico peso.
- Weight relief springs-kit.
- Entlastungsfeder-Satz.
- Kit de ressorts frontales pour du poids.
- Kit de muelles frontales para el descargue del peso.



- Kit segnaletica stradale con luci.
- Set road-warning panels with lights.
- Satz Warntafel mit Beleuchtung.
- Kit de signalisation avec système d'éclairage.
- Kit de señalización de carretera con luces.

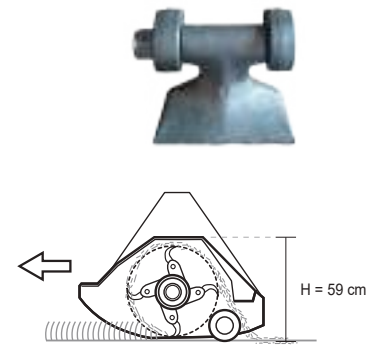

- Pulirullo.
- Roller scraper.
- Satz Walzenabstreifer.
- Décrotoir à rouleau.
- Polirodillo.



- Ruote frontali pivotanti.
- Pivoting front wheels.
- Front- Schwenkräder.
- Roues frontales pivotantes.
- Kit de ruedas frontales pivotantes.



- Albero cardanico.
- Pto drive shaft.
- Gelenkwelle.
- Arbre cardan.
- Cardan.

XPRO/F



STRENX®
PERFORMANCE STEEL



Trinciatrice professionale, rinforzata reversibile applicabile frontalmente o posteriormente o su trattori con guida retroversa con potenza compresa tra 100 e 250 HP. E' consigliata per la trinciatura di erba, paglia, residui vegetali, cespugli, stocchi di mais, sarmenti e residui legnosi fino a Ø 10-12 cm., per la manutenzione di terreni incolti, aree verdi, set-aside.



Front and rear heavy-duty professional mulcher to fit tractors from 100 to 250 HP. It is suited to mulch grass, bushes, maize stalks, corn stalks, sunflowers, scrub and pruning up to Ø 10-12 cm., ideal for general clearing of uncultivated fields, open-field crops, green areas, parks, gardens, under-wood and for set aside applications.



Verstärktes- und Vielseitig-, Front/Heck- Mulchgerät, für Traktoren von 100 bis 250 PS. Mulcht Gras, Stilllegung, Sonnenblumen, Maisstroh, Gestrüpp und Reisig bis Ø 10-12 cm. Es eignet sich für Brachlandpflege, Wiesen, Gründüngung, Obstanlagen, Mais, Zuckerrohr, Rüben usw.



Broyeur professionnel réversible pour tracteurs de 100 à 250 CV. Il est indiqué pour broyer l'herbe, les buissons, les tiges de maïs et de céréales, les tournesols, et les sarments allant jusqu'à Ø 10-12 cm; il est idéal pour le nettoyage général des terrains incultes, des cultures en champs ouverts, des espaces verts, des parcs, des jardins et du sous-bois ou pour des applications similaires.



Trituradora profesional, reforzada reversible aplicable frontalmente o posteriormente o en tractores con conducción inversa con potencia comprendida entre 100 y 250 HP. Está recomendada para el triturado de yerba, paja, residuos vegetales, arbustos, tallos de maíz, sarmientos y residuos leñosos hasta Ø 10-12 cm., para el mantenimiento de terrenos no cultivados, áreas verdes, set-aside.

| Mod. | | | | | | | | | | | | |
|-------------------|-----|-----|-----|----------------------------|----|----|------------|-----|-----|-----|------|------|
| | cm | Min | Max | mm | n° | n° | PTO | A | B | C | min | max |
| XPRO/F 200 | 200 | 100 | 250 | 1250 750 730 1270 | 18 | 5 | 1000 (540) | 122 | 220 | 144 | 1320 | 1600 |
| XPRO/F 230 | 230 | 100 | 250 | 1320 980 800 1500 | 20 | 5 | 1000 (540) | 122 | 250 | 144 | 1410 | 1700 |
| XPRO/F 250 | 250 | 100 | 250 | 1500 1000 980 1520 | 22 | 5 | 1000 (540) | 122 | 270 | 144 | 1475 | 1765 |
| XPRO/F 280 | 280 | 100 | 250 | 1610 1190 1090 1710 | 26 | 5 | 1000 (540) | 122 | 300 | 144 | 1585 | 1875 |
| XPRO/F 300 | 300 | 100 | 250 | 1610 1390 1090 1910 | 28 | 5 | 1000 (540) | 122 | 320 | 144 | 1630 | 1920 |



- Doppio attacco ai tre punti centrale, spostabile idraulicamente, Cat. II-III.
- Double and displaceable 3-point linkage, centre mounted, Cat. II-III (hydraulic).
- Versetzbarer, doppelter und mittlerer Dreipunktbock, Kat. II-III (Hydraulischer).
- Double attelage axial et deportable à 3 points, Cat. II-III (hydraulique).
- Doble engancho central y desplazable a los 3 puntos, Cat. II-III (hidráulico).



- Tenditore automatico delle cinghie.
- Full automatic belts adjuster.
- Automatische Riemenspannung.
- Tendeur automatique des courroies.
- Tensor automático de las correas.



- Rullo posteriore autopulente Ø 220 mm., regolabile in altezza con pulirullo e rastrelli raccoglitori.
- Self-cleaning and adjustable Ø 220 rear roller with scraper and rakes.
- Einstellbare, selbstreinigende Stützwalze Ø 220 mit Abstreifer und Sammelrechen.
- Rouleau palpeur autonettoyant Ø 220, réglable en hauteur avec décrotoir et râteaux ramasseurs.
- Rodillo posterior autolimpiante Ø 220 mm., regulable en altura con polirodillo y rastrillos recogedores.



- Scatola ingranaggi con albero passante e doppia ruota libera.
- Through-shaft and double free wheel in the gearbox.
- Getriebe mit Durchtrieb und doppeltem Freilauf.
- Boîtier avec arbre de sortie arrière et double roue libre.
- Caja de transmisión con eje cardan passante y doble rueda libre.



- Slitte d'appoggio antiusura.
- Skids of anti-wearing steel.
- Satz Kufen mit Anti-Verschleißmaterial.
- Jeu patins anti-usure.
- Patines de acero reforzado anti-desgaste.

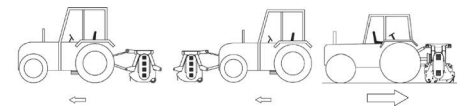

OPTIONALS



- Kit molle anteriori per scarico peso.
- Weight relief springs-kit.
- Entlastungsfeder-Satz.
- Kit de ressorts frontales pour du poids.
- Kit de muelles frontales para el descargue del peso.



- Kit segnaletica stradale con luci.
- Set road-warning panels with lights.
- Satz Warntafel mit Beleuchtung.
- Kit de signalisation avec système d'éclairage.
- Kit de señalización de carretera con luces.

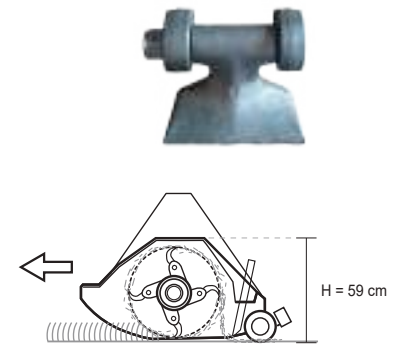

- Ruote frontali pivotanti.
- Pivoting front wheels.
- Front- Schwenkräder.
- Roues frontales pivotantes.
- Kit de ruedas frontales pivotantes.



- Albero cardanico.
- Pto drive shaft.
- Gelenkwelle.
- Arbre cardan.
- Cardan.



bertima.it



EKR



EKR/M



EKR/S



TBM



TBM/S



BIMAX



DUAL



XPRO



XPRO/F

Le illustrazioni e i dati del presente catalogo sono indicative e non vincolanti per il costruttore • All pictures and data above are indicative only and not binding for the manufacturer • Alle in diesem Katalog enthaltenen Angaben und Zeichnungen sind annahmend und unverbindlich • Toutes les données insérées dans ce catalogue ont été indiquées seulement à titre de renseignement • Las fotografías y los datos mostrados son meramente indicativos y podrían ser variados sin previo aviso por el fabricante.



BERTi[®]
MACCHINE AGRICOLE



Via Musi, 1/A-3-4 - 37042 Caldiero (VR) ITALY
Tel. +39.045.6139711 - Fax +39.045.6150251
info@bertima.it



 **MADE IN ITALY**

D016.18 REV03